

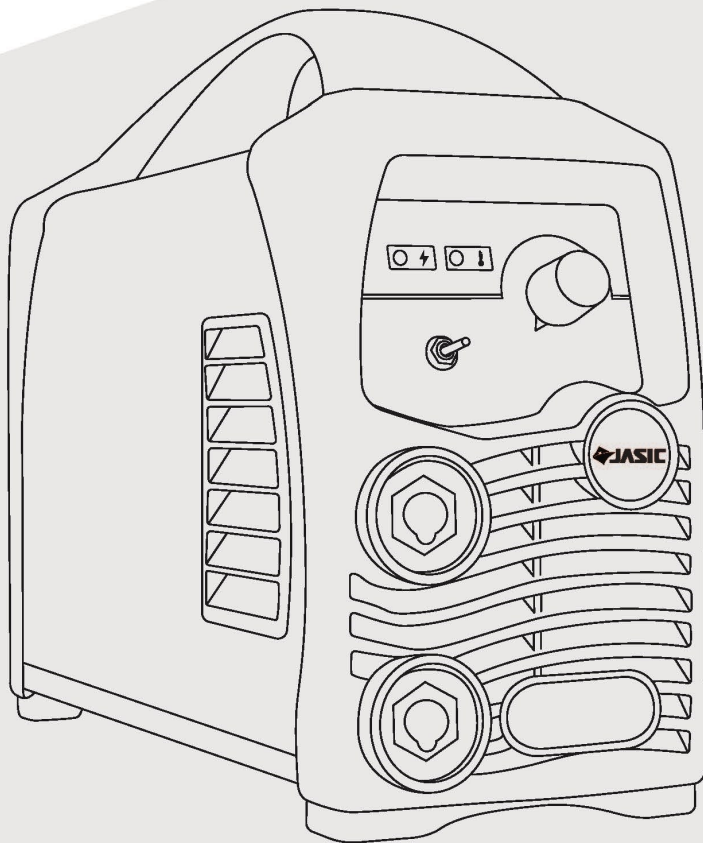

Power Arc Series

Power Arc 160 PFC (JPA-160PFC)

Power Arc 180 (JPA-180SE)



Operator Manual



Intertek

CE

UK
CA



Your new product

Thank you for selecting this Jasic product.

This product manual has been designed to ensure that you get the most from your new product. Please ensure that you are fully conversant with the information provided paying particular attention to the safety precautions. The information will help protect yourself and others against the potential hazards that you may come across.

Please ensure that you carry out daily and periodic maintenance checks to ensure years of reliable and trouble free operation.

Please call your Jasic distributor in the unlikely event of a problem occurring.
Please record below the details from your product as these will be required for warranty purposes and to ensure you get the correct information should you require assistance or spare parts.

Date purchased _____

From where _____

Serial number _____

(The serial number is normally located on the top or underside of the machine and will begin with AA)

For further information on your Jasic product warranty registration please visit:

www.jasic-warranty.co.uk

Disclaimer

Whilst every effort has been made to ensure that the information contained within this manual is complete and accurate, no liability can be accepted for any errors or omissions. Please note products are subject to continual development and may be subject to change without notice.

No part of this manual may be copied or reproduced by any means without the written permission of Wilkinson Star Limited.

CONTENTS

Index	Page
Your New Product	2
Index	3
Safety Instruction	4
General electrical safety	4
General operating safety	4
PPE	5
Welding processes lens shade selector guide	5
Fume and welding gases	6
Fire risks	6
The working environment	7
Protection from moving parts	7
Magnetic fields	7
Compressed gas cylinders and regulators	7
RF declaration	8
LF declaration	8
Materials and their disposal	8
Product Overview	9
Technical Specifications	10
Description of Controls	11
Installation	12
Operation	13
Guide to MMA Welding	15
MMA Welding Problems	19
Maintenance and Troubleshooting	20
WEEE Disposal	21
RoHS Compliance Declaration	21
UKCA Declaration of Conformity	21
EC Declaration of Conformity	22
Statement of Warranty	24
Schematic	25
Options and Accessories	25
Notes	26
Jasic Contact Details	28

SAFETY INSTRUCTION

These general safety norms cover both arc welding machines and plasma cutting machines unless otherwise noted.

It is important that users of this equipment protect yourselves and others from harm or even death. The equipment must only be used for the purpose it was designed for. Using it in any other way could result in damage or injury and in breach of the safety rules.

Only suitably trained and competent persons should use the equipment.

Pacemaker wearers should consult your doctor prior to using this equipment.

PPE and workplace safety equipment must be compatible for the application of work involved.

Always carry out a risk assessment before carrying out any welding or cutting activity

General electrical safety



The equipment should be installed by a qualified person and in accordance with current standards in accordance with current standards in operation. It is the users responsibility to ensure that the equipment is connected to a suitable power supply. Consult with your utility supplier if required. Do not use the equipment with the covers removed.

Do not touch live electrical parts or parts which are electrically charged.

Turn off all equipment when not in use.

In the case of abnormal behaviour of the equipment, the equipment should be checked by a suitably qualified service engineer.

If earth bonding of the work piece is required, bond it directly with a separate cable with a current carrying capacity capable of carrying the maximum capacity of the machine current.

Cables (both primary supply and welding) should be regularly checked for damage and overheating.

Never use worn, damaged, under sized or poorly jointed cables.

Insulate yourself from work and earth using dry insulating mats or covers big enough to prevent any physical contact.

Never touch the electrode if you are in contact with the work piece return.

Do not wrap cables over your body.

Ensure that you take additional safety precautions when you are welding in electrically hazardous conditions such as damp environments, wearing wet clothing and metal structures.

Try to avoid welding in cramped or restricted positions.

Ensure that the equipment is well maintained. Repair or replace damaged or defective parts immediately.

Carry out any regular maintenance in accordance with the manufacturers instructions.

The EMC classification of this product is class A in accordance with electromagnetic compatibility standards CISPR 11 and IEC 60974-10 and therefore the product is designed to be used in industrial environment only.

WARNING: This class A equipment is not intended for use in residential locations where the electrical power is provided by a public low-voltage supply system. In those locations it may be difficult to ensure the electromagnetic compatibility due to conducted and radiated disturbances.

General operating safety

Never carry the equipment or suspend it by the carrying strap or handles during welding.

Never pull or lift the machine by the welding torch or other cables. Always use the correct lift points or handles. Always use the transport under gear as recommended by the manufacturer.

Never lift a machine with the gas cylinder mounted on it.

If the operating environment is classified as dangerous, only use S-marked welding equipment with a safe idle voltage level. Such environments may be for example: humid, hot or restricted accessibility spaces.

SAFETY INSTRUCTION

Use of Personal Protective Equipment (PPE)

Welding arc rays from all welding processes produce intense, visible and invisible (ultraviolet and infrared) rays that can burn eyes and skin.

- Wear an approved welding helmet fitted with an appropriate shade of filter lens to protect your face and eyes when welding or watching.
- Wear approved safety glasses with side shields under your helmet.
- Never use broken or faulty welding helmets.
- Always ensure there are adequate protective screens or barriers to protect others from flash, glare and sparks from the welding area.
- Ensure that there are adequate warnings that welding or cutting is taking place.
- Wear suitable protective flame resistant clothing, gloves and footwear.
- Check and be sure the area is safe and clear of inflammable material before carrying out any welding.

Some welding and cutting operations may produce noise. Wear safety ear protection to protect your hearing if the ambient noise level exceeds the local allowable limit (e.g: 85 dB).



Welding and Cutting Lens Shade Selector Guide

CURRENT	MMA ELECTRODES	MIG LIGHT ALLOYS	MIG HEAVY METALS	MAG	TIG ON ALL METALS	PLASMA CUTTING	PLASMA WELDING	GOUGING ARC/AIR
10	8							
15								
20	9	10	10	10	10			
30								
40	10					11	11	
60								
80	11				11			10
100								
125	11	11		11				
150								
175	12			12				
200								
225	12	12			13	12	13	11
250								
275	13	13						12
300								
350	13	14			14		14	13
400								
450	14	15		14				14
500								

SAFETY INSTRUCTION

Safety against fumes and welding gases



The HSE have identified welders as being an 'at risk' group for occupational diseases arising from exposure to dusts, gases, vapours and welding fumes. The main identified health effects are pneumonia, asthma, chronic obstructive pulmonary disease (COPD), lung and kidney cancer, metal fume fever (MFF) and lung function changes.

During welding and hot cutting 'hot work' operations, fumes are produced which are collectively known as welding fume. Depending upon the type of welding process being performed, the resultant fume generated is a complex and highly variable mixture of gases and particulates.

Regardless of the length of welding being carried out, all welding fume, including mild steel welding requires suitable engineering controls to be in place which is usually Local Exhaust Ventilation (LEV) extraction to reduce the exposure to welding fume indoors and where LEV does not adequately control exposure it should also be enhanced by using suitable respiratory protective equipment (RPE) to assist with protecting against residual fume. When welding outdoors appropriate RPE should be used.

Prior to undertaking any welding tasks an appropriate risk assessment should be carried out to ensure expected control measures are in place.

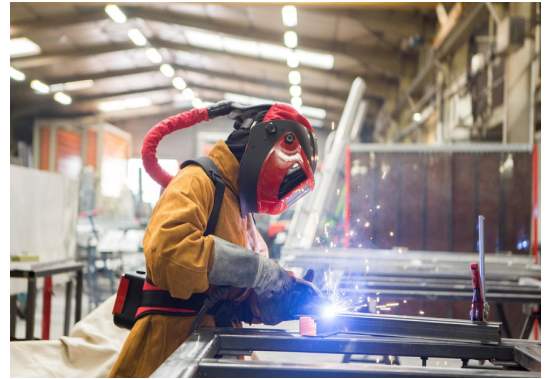

An example of personal fume protection

Locate the equipment in a well-ventilated position and keep your head out of the welding fume.

Do not breathe the welding fume.

Ensure the welding zone is well-ventilated and provision should be made for suitable local fume extraction system to be in place.

If ventilation is poor, wear an approved airfed welding helmet or respirator.

Read and understand the Material Safety Data Sheets (MSDS's) and the manufacturer's instructions for metals, consumable, coatings, cleaners and de-greasers.

Do not weld in locations near any de-greasing, cleaning or spraying operations.

Be aware that heat and rays of the arc can react with vapours to form highly toxic and irritating gases.

For further information please refer to the HSE website www.hse.gov.uk for related documentation.

Precautions against fire and explosion



Avoid causing fires due to sparks and hot waste or molten metal.

Ensure that appropriate fire safety devices are available near the welding and cutting area.

Remove all flammable and combustible materials from the welding, cutting and surrounding areas.

Do not weld or cut fuel and lubricant containers, even if empty. These must be carefully cleaned before they can be welded or cut.

Always allow the welded or cut material to cool before touching it or placing it in contact with combustible or flammable material.

Do not work in atmospheres with high concentrations of combustible fumes, flammable gases and dust.

Always check the work area half an hour after cutting to make sure that no fires have begun.

Take care to avoid accidental contact of electrode to metal objects. This could cause arcs, explosion, overheating or fire.



Understand your fire extinguishers

SAFETY INSTRUCTION

The working environment

Ensure the machine is mounted in a safe and stable position allowing for cooling air circulation.

Do not operate equipment in an environment outside the laid down operating parameters.

The welding power source is not suitable for use in rain or snow.

Always store the machine in a clean, dry space.

Ensure the equipment is kept clean from dust build up.

Always use the machine in an upright position.

Protection from moving parts

When the machine is in operation keep away from moving parts such as motors and fans.

Moving parts, such as the fan, may cut fingers and hands and snag garments.

Protections and coverings may be removed for maintenance and controls only by qualified personnel after first disconnecting the power supply cable.

Replace the coverings and protections and close all doors when the intervention is finished and before starting the equipment.

Take care to avoid getting fingers trapped when loading and feeding wire during set up and operation.

When feeding wire be careful to avoid pointing it at other people or towards your body.

Always ensure machine covers and protective devices are in operation.

Risks due to magnetic fields



The magnetic fields created by high currents may affect the operation of pacemakers or electronically controlled medical equipment.

Wearers of vital electronic equipment should consult their physician before beginning any arc welding, cutting, gouging or spot welding operations.

Do not go near welding equipment with any sensitive electronic equipment as the magnetic fields may cause damage.

Keep the torch cable and work return cable as close to each other as possible throughout their length. This can help minimise your exposure to harmful magnetic fields.

Do not wrap the cables around the body.

Handling of compressed gas cylinders and regulators

Mishandling gas cylinders can lead to rupture and the release of high pressure gas.

Always check the gas cylinder is the correct type for the welding to be carried out.

Always store and use cylinders in an upright and secure position.

All cylinders and pressure regulators used in welding operations should be handled with care.

Never allow the electrode, electrode holder or any other electrically "hot" parts to touch a cylinder.

Keep your head and face away from the cylinder valve outlet when opening the cylinder valve.

Always secure the cylinder safely and never move with regulator and hoses connected.

Use a suitable trolley for moving cylinders.

Regularly check all connections and joints for leaks.

Full and empty cylinders should be stored separately.

Never deface or alter any cylinder

SAFETY INSTRUCTION

RF Declaration

Equipment that complies with directive 2014/30/EU concerning electromagnetic compatibility (EMC) and the technical requirements of EN60974-10 is designed for use in industrial buildings and not those for domestic use where electricity is provided via the low voltage public distribution system.

Difficulties may arise in assuring class A electromagnetic compatibility for systems installed in domestic locations due to conducted and radiated emissions.

In the case of electromagnetic problems, it is the responsibility of the user to resolve the situation.

It may be necessary to shield the equipment and fit suitable filters on the mains supply.

LF Declaration

Consult the data plate on the equipment for the power supply requirements.

Due to the elevated absorbance of the primary current from the power supply network, high power systems affect the quality of power provided by the network. Consequently, connection restrictions or maximum impedance requirements permitted by the network at the public network connection point must be applied to these systems.

In this case, the installer or the user is responsible for ensuring the equipment can be connected, consulting the electricity provider if necessary.

Materials and their disposal

Welding equipment is manufactured with BSI published standards meeting CE requirements materials which do not contain any toxic or poisonous materials dangerous to the operator.

Do not dispose of the equipment with normal waste. The European Directive 2012/19/EU on Waste Electrical and Electronic Equipment states the electrical equipment that has reached its end of life must be collected separately and returned to an environmentally compatible recycling facility for disposal.

For more detailed information please refer to the HSE website www.hse.gov.uk

PRODUCT OVERVIEW

The Jasic MMA inverter range of welding machines have been designed as integrated and portable welding power supply units incorporating the most advanced IGBT inverter technology in power electronics.



Jasic Power Arc 160 PFC and 180 Product Features:

- Compact size, lightweight and modern design
- Supplied in a tough plastic case complete with welding leads
- Advanced IGBT inverter technology
- High frequency inverter which contributes to reducing product weight and size
- Built in self adaptive hot start arc ignition function which ensures excellent arc ignition in MMA for easier and more reliable arc starting
- Built in adjustable arc force technology which maintains the optimum arc conditions during welding even with long cables
- Excellent weld characteristics
- Auto compensation for mains voltage fluctuation
- Heavy duty 35-50mm dinse sockets
- Suitable for a wide range of electrodes
- Easy arc starting, low spatter, stable current which offers good weld bead shape
- Generator friendly
- High quality tactile finish to mouldings and handle

TECHNICAL SPECIFICATIONS

Parameter	Unit	Jasic Power Arc 160 PFC (JPA-160PFC)	Jasic Power Arc 180 SE (JPA-180)
Rated input voltage	V	AC 95 - 230V ±15% 50/60Hz	AC 230V ±15% 50/60Hz
Rated input power	kVA	115V - 3.7 230V - 5	230V - 8.3
Rated input current I _{max}	A	115V - 32.6 230V - 21.4	230V - 36
Rated input current I _{eff}	A	115V - 17.5 230V - 11.6	230V - 21.3
Welding current range	A	115V - 10 ~ 125 230V - 10 ~ 160	230V - 10 ~ 180
No-load voltage	V	115V - MMA 68 115V - TIG 9 230V - MMA 68 230V - TIG 9	230V - MMA 68 230V - TIG 9
Rated duty cycle	%	115V - 125A @ 35% (40°C) 230V - 160A @ 35% (40°C)	230V - 180A @ 35% (40°C)
Efficiency	%	85	85
Power factor	cosφ	0.998	0.7
Standard	-	EN60974-1	EN60974-1
Protection class	IP	IP21S	IP21S
Insulation class	-	F	F
Noise	Db	<70	<70
Operating temperature	°C	-10 ~ +40	-10 ~ +40
Storage temperature	°C	-25 ~ +55	-25 ~ +55
Size (with handle)	mm	365 x 135 x 280	315 x 130 x 250
Size (without handle)	mm	315 x 130 x 235	315 x 130 x 206
Weight	Kg	6.4	4.7

Please Note

Due to variations in manufactured products all claimed performance ratings, capacities, measurements, dimensions and weights quoted are approximate only. Achievable performance and ratings when in use can depend upon correct installation, applications and use along with regular maintenance and service.

CONTROLS

Front view Jasic Power Arc 160 PFC

1. Overheating LED: Overheating LED on indicates that the temperature inside the machine is too high and the machine is under overheating protection status
2. Power LED: Power LED on indicates that the power switch of the machine is on
3. Welding current knob: To adjust the output current
4. MMA/TIG switch: To toggle between MMA and TIG
5. "+" Output terminal*: To connect the electrode holder
6. "-" Output terminal*: To connect the work clamp

* Panel socket size is 35/50mm

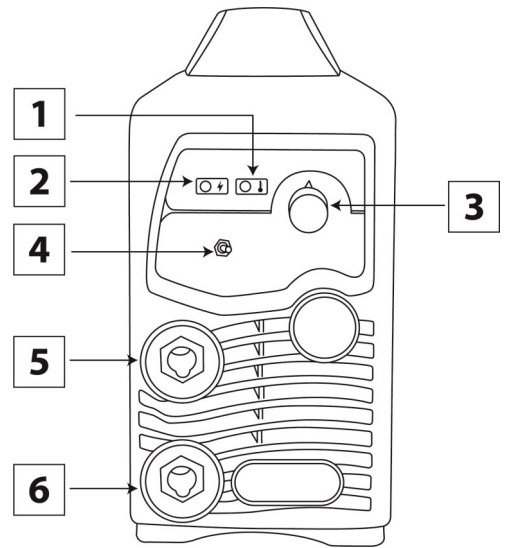

Front view Jasic Power Arc 180 SE

1. Overheating LED: Overheating LED on indicates that the temperature inside the machine is too high and the machine is under overheating protection status
2. Power LED: Power LED on indicates that the power switch of the machine is on
3. Welding current knob: To adjust the output current
4. MMA/TIG switch: To toggle between MMA and TIG
5. "+" Output terminal*: To connect the electrode holder
6. "-" Output terminal*: To connect the work clamp

Panel socket size is 35/50mm

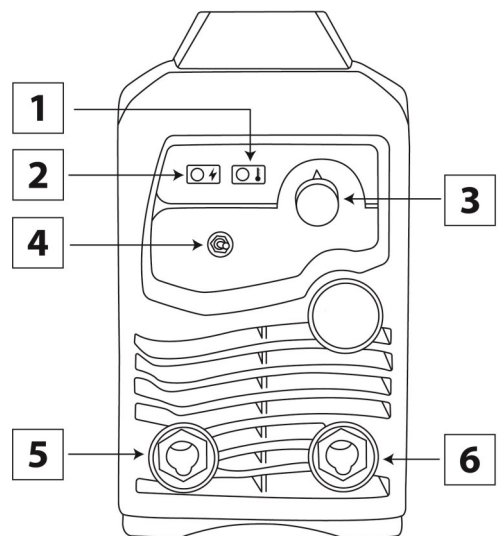

Rear view Jasic Power Arc 160 PFC and 180 SE

7. Input cable gland
8. Cooling fan
9. Power switch

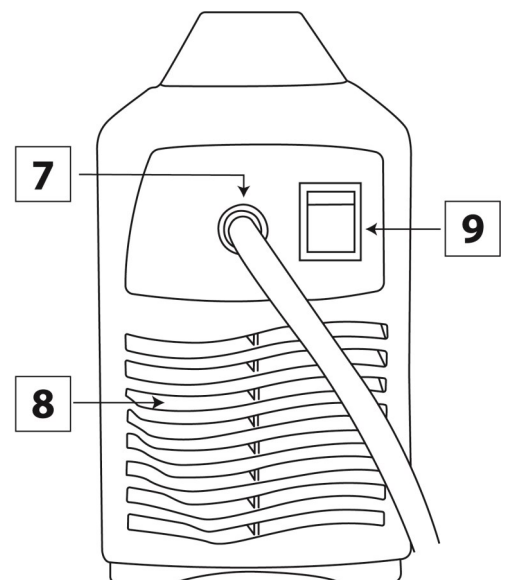

INSTALLATION

Unpacking

Check the packaging for any signs of damage.

Carefully remove the machine and retain the packaging until the installation is complete.

Location

The machine should be located in a suitable position and environment. Care should be taken to avoid moisture, dust, steam, oil or corrosive gases.

Place on a secure level surface and ensure that there is adequate clearance around the machine to ensure natural airflow.

Input connection

Before connecting the machine you should ensure that the correct supply is available. Details of the machine requirements can be found on the data plate of the machine or in the technical parameters shown in the manual.

The equipment should be connected by a suitably qualified competent person. Always ensure the equipment has a proper grounding.

Never connect the machine to the mains supply with the panels removed.

Output connections

Electrode polarity

In general when using manual arc welding electrodes the electrode holder is connected to the positive terminal and the work return to the negative terminal. Always consult the electrode manufacturer's data sheet if you have any doubts.

When using the machine for TIG welding the TIG torch should be connected to the negative terminal and the work return to the positive terminal.

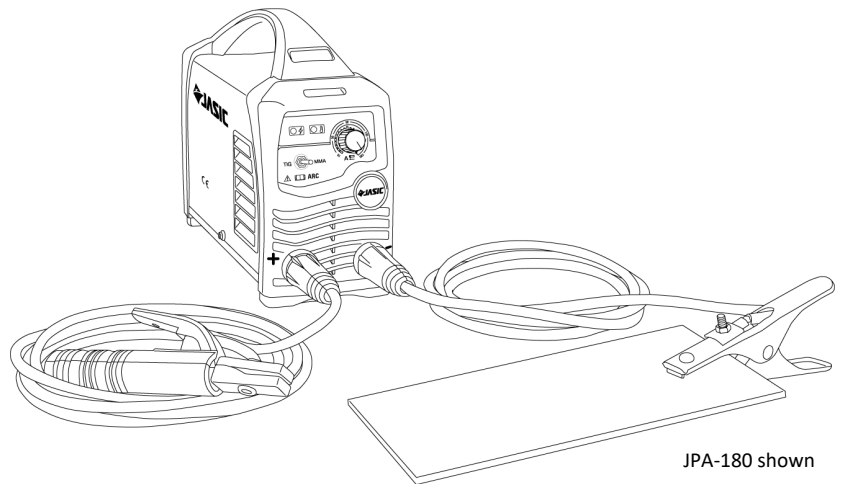

MMA welding

Insert the cable plug with electrode holder into the “+” socket on the front panel of the welding machine and tighten it clockwise.

Insert the cable plug of the work return lead into the “-” socket on the front panel of the welding machine and tighten it clockwise.

Please Note:

Check these power connections daily to ensure they have not become loose otherwise arcing may occur when used under load.

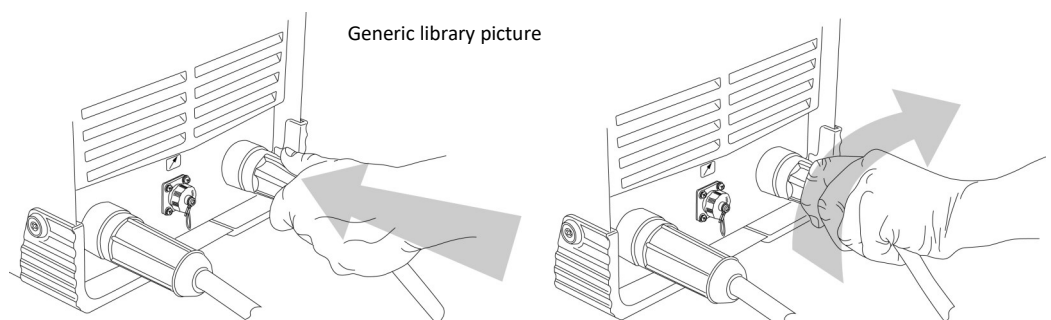

OPERATION - MMA



Before starting any welding activity ensure that you have suitable eye protection and protective clothing. Also take the necessary steps to protect any persons within the welding area.

MMA welding

MMA (Manual Metal Arc), SMAW (Shielded Metal Arc Welding) or just Stick Welding. Stick welding is an arc welding process which melts and joins metals by heating them with an arc between a covered metal electrode and the work.

Shielding is obtained from the electrode outer coating, often called flux. Filler metal is primarily obtained from the electrode core.

The electrodes outer coating called flux assists in creating the arc and provides a shielding gas and on cooling forms a slag covering to protect the weld from contamination.

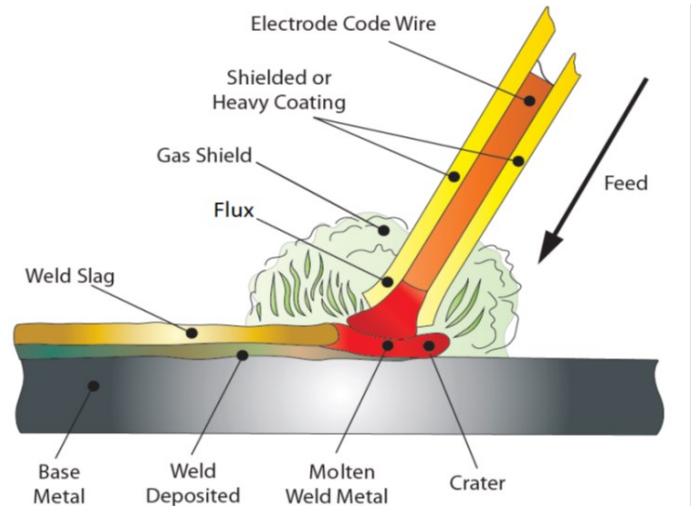

When the electrode is moved along the work piece at the correct speed the metal core deposits a uniformed layer called the weld bead.

JPA-160PFC shown

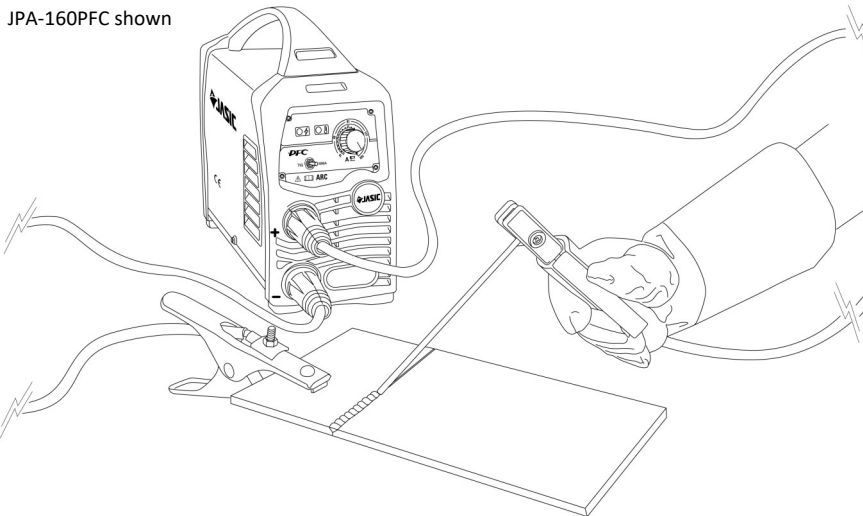

After connecting the welding leads as detailed you will need to switch the power switch on the back panel to "ON".

Select MMA by switching to MMA welding mode on the MMA/TIG switch. There is voltage output at both output terminals.

Ensure you check that you have the electrode polarity correct.

Set the amperage on the machine suitable for the electrode being used.

Please see guide below to amperages required, although this MMA welding electrode guide can vary depending on material, work piece thickness, welding position and joint form.

Electrode Diameter (mm)	Recommended Welding Current (A)
1.0	20 ~ 60
1.6	44 ~ 84
2.0	60 ~ 100
2.5	80 ~ 120
3.2	108 ~ 148
4.0	140 ~ 180
5.0	160 ~ 250

OPERATION - TIG



Before starting any welding activity ensure that you have suitable eye protection and protective clothing. Also take the necessary steps to protect any persons within the welding area.

TIG welding

Insert the cable plug with the work clamp into the “+” socket on the front panel of the welding machine and tighten clockwise.

Insert the cables plug of the TIG torch into the “-” socket on the front panel of the machine and tighten clockwise.

Connect the TIG torch gas hose to the flowmeter that is connected to the regulator which is located on the shield gas cylinder.

Before starting any welding activity ensure that you have suitable eye protection and protective clothing.

Also take the necessary steps to protect any persons within the area.

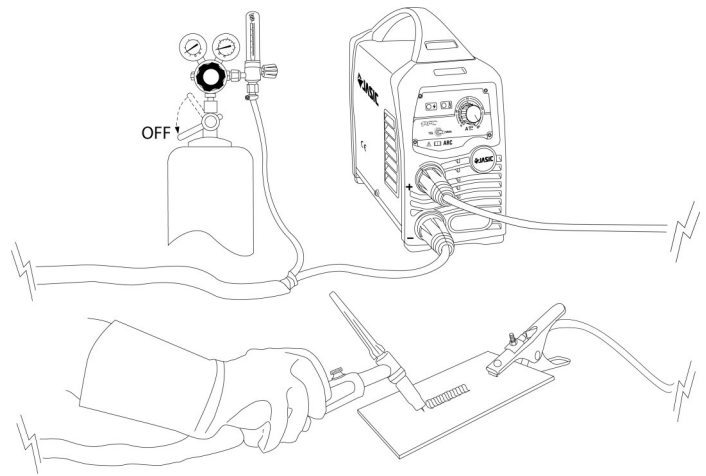

JPA 160PFC shown

After connecting the welding leads as detailed you will need to switch the power switch on the back panel to “ON”. Select Lift TIG by switching to TIG on the MMA/TIG welding mode switch. (Note, there is voltage output at both output terminals).

Set the amperage on the machine suitable for the electrode being used. (For a guide to tungsten sizes, please refer to the table below). Ensure you have adequate welding current according to the thickness of the work and weld prep being carried out and filler wire being used.

Lift TIG description

Open the gas valve of the cylinder and adjust the gas regulator to obtain the desired flow rate. Open the gas torch valve located close to the torch head and the gas will flow.

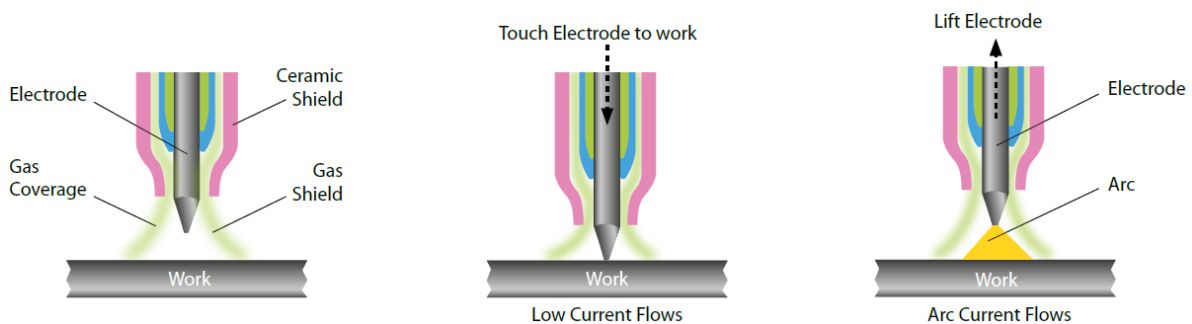

The Jasic Arc range allows the tungsten to be in direct contact with the work piece with minimal current so as not to leave tungsten deposits. Once contact has been made the tungsten can then be lifted away 2-4mm from the work piece and the welding arc is then established.

Once welding is complete pull the torch away to disengage the welding arc but ensure you leave the torch in place to shield the weld with gas for a few seconds and then turn off the gas at the valve on the torch head.

Tungsten Size	DC – Electrode Negative
1.0mm	15 – 80A
1.6mm	70 – 150A
2.4mm	150 – 250A
3.2mm	250A – 400A

GUIDE TO MMA WELDING



Before starting any welding activity ensure that you have suitable eye protection and protective clothing. Also take the necessary steps to protect any persons within the welding area.

Notes for the welding beginner

This section is designed to give the beginner who has not yet done any welding some information to get them going. The simplest way to start is to practice by running weld beads on a piece of scrap plate. Start by using mild steel (paint free) plate of 6.0mm thick and using 3.2mm electrodes. Clean any grease, oil and loose scale from the plate and fix firmly to your work bench so that welding can be carried out. Make sure that the work return clamp is secure and making good electrical contact with the mild steel plate, either directly or through the work table. For best results always clamp the work lead directly to the material being welded, otherwise a poor electrical circuit may create itself.

Welding position

When welding, ensure you place yourself in a comfortable position for welding and your welding application before you begin to weld. This may be sitting at a suitable height which often is the best way to weld ensuring you're relaxed and not tense. A relaxed posture will ensure the welding task becomes much easier.

Please ensure you always wear suitable PPE and use suitable fume extraction when welding.

Place the work so that the direction of welding is across, rather than to or from your body. The electrode holder lead should always be clear of any obstruction so that you can move your arm freely along as the electrode burns down. Some welders prefer to have the welding lead over their shoulder, this allows greater freedom of movement and can reduce the weight from your hand.

Always inspect your welding equipment, welding cables and electrode holder before each use to ensure it's not faulty or worn as you may be at risk of an electric shock.

MMA process features and benefits

The versatility of the process and the skill level required to learn, basic simplicity of the equipment make the MMA process one of the most common used throughout the world.

The MMA process can be used to weld a wide variety of materials and is normally used in the horizontal position but can be used in vertical or overhead with the correct selection of electrode and current. In addition, it can be used to weld at long distances from the power source subject to the correct cable sizing. The self shielding effect of the electrode coating makes the process suitable for welding in external environments. It is the dominant process used in maintenance and repair industries and is used extensively in structural and fabrication work.

The process is well able to cope with less than ideal material conditions such as dirty or rusty material. Disadvantages of the process are the short welds, slag removal and stop starts which lead to poor weld efficiency which is in the region of 25%. The weld quality is also highly dependent on the skill of the operator and many welding problems can exist.

GUIDE TO MMA WELDING



Before starting any welding activity ensure that you have suitable eye protection and protective clothing. Also take the necessary steps to protect any persons within the welding area.

MMA process tips and guides

Typical welder set up

1. Electrode holder
2. Work return clamp
3. Work piece
4. Weld material covered by electrode flux or slag
5. Electrode
6. Distance from work to electrode (arc Length)

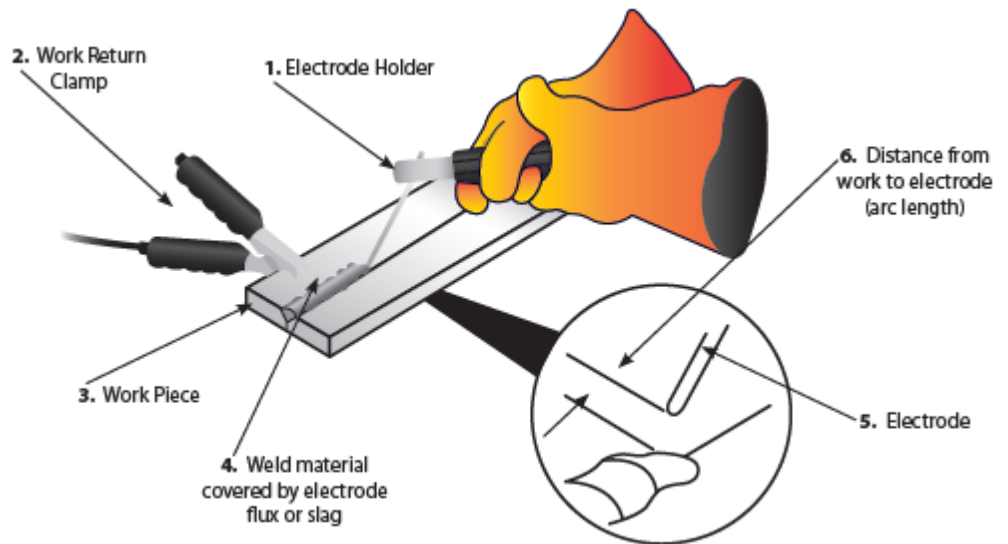

Welding current will flow in the circuit as soon as the electrode contacts the work piece. The welder should always ensure a good connection of the work clamp. The nearer the clamp is placed to the welding area the better.

When the arc is struck the distance between the end of the electrode and the work will determine the arc voltage and also affect the weld characteristic. As a guide the arc length for electrodes up to 3.2mm diameter should be around 1.6mm and over 3.2mm around 3mm.

Upon completion of the weld the welding flux or slag will need to be removed usually with a chipping hammer and wire brush.

Joint form in MMA

In MMA welding, the common basic joint forms: butt joint, corner joint, lap joint & T joint.

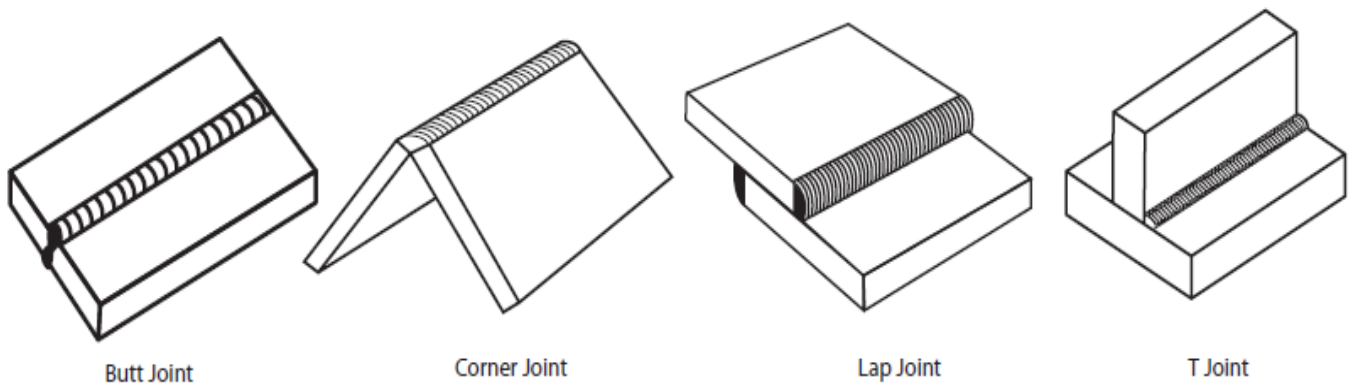

GUIDE TO MMA WELDING



Before starting any welding activity ensure that you have suitable eye protection and protective clothing. Also take the necessary steps to protect any persons within the welding area.

MMA arc striking

Tap technique - Lift the electrode upright and bring it down to strike the work piece. After forming short circuit, quickly lift up about 2~4mm and arc will be ignited. This method is difficult to master.

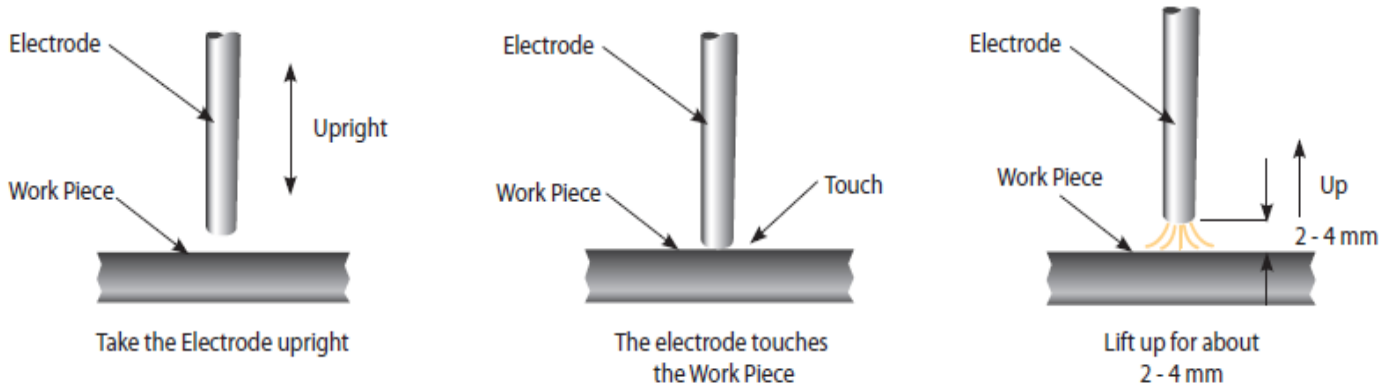

Scratch technique - Drag the electrode and scratch the work piece as if striking a match. Scratching the electrode may cause the arc to burn along the scratch path, so care should be taken to scratch in the weld zone. When the arc is struck adopt the correct welding position.

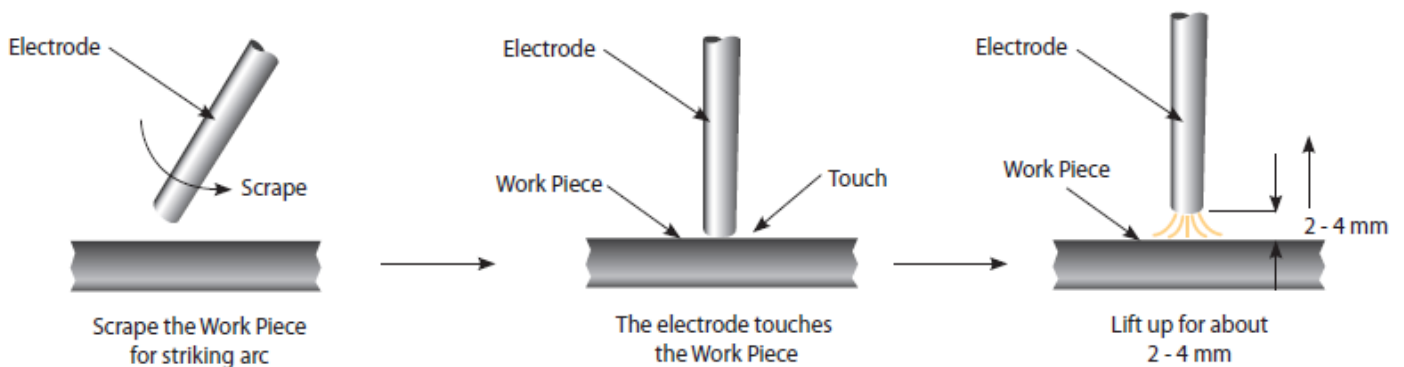

Electrode positioning

Horizontal or flat position

The electrode should be positioned at right angles to the plate and inclined in the direction of travel at around 10°-30°.

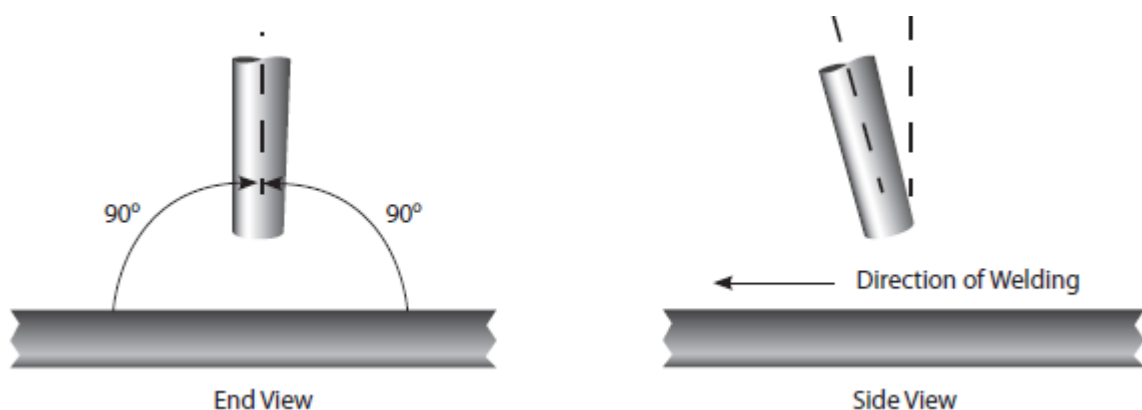

GUIDE TO MMA WELDING



Before starting any welding activity ensure that you have suitable eye protection and protective clothing. Also take the necessary steps to protect any persons within the welding area.

Fillet welding

The electrode should be positioned to split the angle i.e. 45° . Again the electrode should be inclined in the direction of travel at around 10° - 30° .

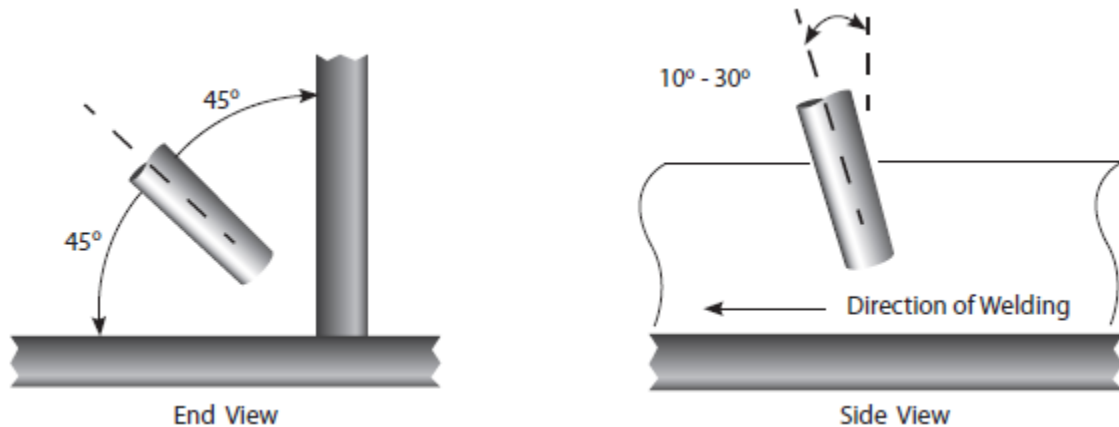

Manipulation of electrode

In MMA welding there are three motions used at the end of electrode:

1. The electrode feeding to the molten pool along axes
2. The electrode swing right and left
3. The electrode moving in the weld direction

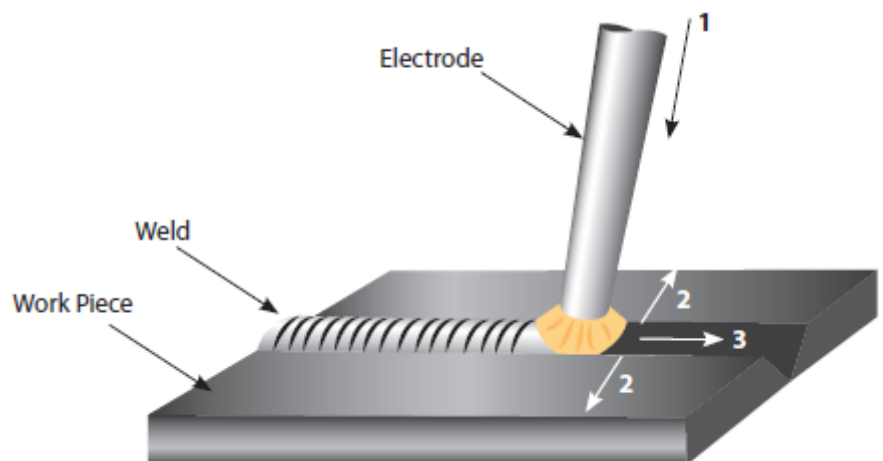

The operator can choose the manipulation of electrode based on welding joint, welding position, electrode spec, welding current and operation skill etc.

Weld characteristics

A good weld bead should exhibit the following characteristics:

1. Uniform weld bead
2. Good penetration into the base material
3. No overlap
4. Fine spatter level

A poor weld bead should exhibit the following characteristics:

1. Uneven and erratic bead
2. Poor penetration into the base material
3. Bad overlap
4. Excessive spatter levels
5. Weld crater

MMA WELDING PROBLEMS



Before starting any welding activity ensure that you have suitable eye protection and protective clothing. Also take the necessary steps to protect any persons within the welding area.

Arc welding defects and prevention methods

<u>Defect</u>	<u>Possible cause</u>	<u>Action</u>
Excessive spatter (beads of metal scattered around the weld area)	Amperage too high for the selected electrode	Reduce amperage or utilise larger diameter electrode
	Voltage too high or arc length too long	Reduce arc length or voltage
Uneven and erratic weld bead and direction	Weld bead is inconsistent and misses joint due to operator	Operator training required
Lack of penetration – The weld bead fails to create complete fusion between material to be welded, often surface appears okay but weld depth is shallow	Poor joint preparation	Joint design must allow for full access to the root of the weld
	Insufficient heat input	Material too thick Increase the amperage or increase the electrode size and amperage
	Poor weld technique	Reduce travel speed Ensure the arc is on the leading edge of the weld puddle
Porosity – Small holes or cavities on the surface or within the weld material	Work piece dirty	Remove all contaminant from the material i.e. oil, grease, rust, moisture prior to welding
	Electrode is damp	Replace or dry the electrode
	Arc length is excessive	Reduce the arc length
Excessive penetration – The weld metal is below the surface level of the material and hangs below	Heat input too high	Reduce the amperage or use a smaller electrode and lower amperage
	Poor weld technique	Use correct welding travel speed
Burning through – Holes within the material where no weld exists	Heat input too high	Use lower amperage or smaller electrode Use correct welding travel speed
Poor fusion – Failing of weld material to fuse either with the material to be welded or previous weld beads	Insufficient heat level	Increase the amperage or increase the electrode size and amperage
	Poor welding technique	Joint design must allow for full access to the root of the weld Alter welding technique to ensure penetration such as weaving, arc positioning or stringer bead technique
	Work piece dirty	Remove all contaminant from the material i.e. oil, grease, rust, moisture prior to welding

MAINTENANCE AND TROUBLESHOOTING



The following operation requires sufficient professional knowledge on electric aspects and comprehensive safety knowledge. Make sure the input cable of the machine is disconnected from the electricity supply and wait for 5 minutes before removing the machine covers.

Maintenance

In order to guarantee that the arc welding machine works efficiently and in safety, it must be maintained regularly. Operators should understand the maintenance methods and means of arc welding machine operation. This guide should enable customers to carry out simple examination and safeguarding by oneself, try to reduce the fault rate and repair times of the arc welding machine, so as to lengthen service life of arc welding machines.

<u>Period</u>	<u>Maintenance item</u>
Daily examination	Check the condition of the machine, mains cables, welding cables and connections. Check for any warnings LEDs and machine operation.
Monthly examination	Disconnect from the mains supply and wait for at least 5 minutes before removing the cover. Check internal connections and tighten if required. Clean the inside of the machine with a soft brush and vacuum cleaner. Take care not to remove any cables or cause damage to components. Ensure that ventilation grills are clear. Carefully replace the covers and test the unit. This work should be carried out by a suitably qualified competent person.
Yearly examination	Carry out an annual service to include a safety check in accordance with the manufacturers standard (EN 60974-1). This work should be carried out by a suitably qualified competent person.

Troubleshooting

Before arc welding machines are dispatched from the factory, they have already been checked thoroughly. The machine should not be tampered with or altered. Maintenance must be carried out carefully. If any wire becomes loose or is misplaced, it maybe potentially dangerous to user!

Only professional maintenance personnel should repair the machine!

Ensure the power is disconnected before working on the machine. Always wait 5 minutes after power switch off before removing the panels.

<u>Description of fault</u>	<u>Possible cause</u>	<u>Action</u>
The welding arc cannot be established	Power switch has not been switched ON Incoming mains power supply is not ON Possible internal power failure	- Switch ON power switch - Check incoming power switch for correct supply - Have a technician check the machine and supply
Difficult arc ignition	Low arc current	- Increase the arc current setting - Check condition of the MMA welding leads
Overheat LED lit	Machine operated outside duty cycle Fan not working	- Allow the machine to cool and the unit will reset automatically - Have a technician check for obstructions blocking the fan
Over current LED lit	Mains supply problem	- Have a technician check the mains supply

WEEE disposal

The equipment is manufactured with materials which do not contain any toxic or poisonous materials dangerous to the operator.

When the equipment is scrapped, it should be dismantled separating components according to the type of materials.

Do not dispose of the equipment with normal waste. The European Directive 2002/96/EC and United Kingdom's Directive The Waste Electrical and Electronic Equipment (WEEE) regulations 2013 states that electrical equipment that has reached its end of life must be collected separately and returned to an environmentally compatible recycling facility.

Jasic has a relevant recycling system which is compliant and registered in the UK with the environment agency. Our registration reference is WEEMM3813AA.

In order to comply with WEEE regulations outside the UK you should contact your supplier.

RoHS Compliance Declaration

We herewith confirm, that the above mentioned product does not contain any of the restricted substances as listed in EU Directive 2011/65/EU and the UK directive ROHS Regulations 2012 in concentrations above the limits as specified therein.

UKCA Declaration of Conformity

The manufacturer, or its legal representative Wilkinson Star Limited, declares that the equipment described below is designed and produced according to following UK legislation:

- Electrical equipment safety 2016
- Electromagnetic compatibility (EMC) regulations 2016
- The restrictions of the use of certain hazardous substances in electrical and electronic equipment regulations 2012

And inspected according to following designated standards:

- EN 60 974-1:2018+A1:2019
- EN 60 974-10:2014+A1:2015

Any alteration or change to these machines by any unauthorized person makes this declaration invalid.

Models:

JPA-160PFC

JPA-180SE

Authorised Representative:

Wilkinson Star Limited
Shield Drive
Wardley Industrial Estate
Worsley
Manchester
M28 2WD

Disclaimer:

Please note that this confirmation is given to the best of our present knowledge and belief. Nothing herein represents and/or may be interpreted as warranty within the meaning of the applicable warranty law.

EC Declaration of Conformity

EC DECLARATION OF CONFORMITY

The manufacturer, or its legal representative **Wilkinson Star Limited**, declares that the equipment described below is designed and produced according to following EU Directives:

- Low Voltage Directive (LVD), No.: 2014/35/EU
- Electromagnetic compatibility (EMC) Directive, No.: 2014/30/EU

And inspected according to following

EU - Norms:

- EN 60 974-1:2012
- EN 60 974-10:2014+A1

Any alteration or change to these machines by any unauthorized person makes this Declaration invalid.

Wilkinson Star model

JA-160 PFC

JA-180 PFC

JA-200 PFC

Jasic Model

Arc 160 PFC Z221

Arc 180 PFC Z222

Arc 200 PFC Z229

Authorised Representative

Wilkinson Star Limited
Shield Drive, Wardley Industrial Estate,
Worsley, Manchester M28 2WD
Tel 0161 793 8127

Signature

Dr John A Wilkinson OBE

Position Chairman

Manufacturer

Shenzhen Jasic Technology Co LTD
No3 Qinglan, 1st Road
Pingshan District
Shenzhen, China

Signature

Shenzhen Jasic Technology Co LTD

Position

Date



Company stamp

Date

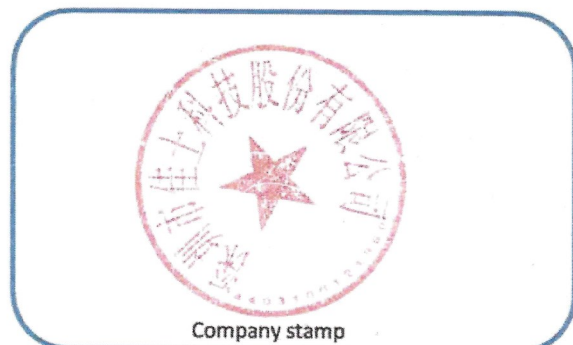

Company stamp

EC Declaration of Conformity

The manufacturer, or its legal representative **Wilkinson Star Limited**, declares that the equipment described below is designed and produced according to following EU Directives:

- Low Voltage Directive (LVD), No.: 2014/35/EU
- Electromagnetic compatibility (EMC) Directive, No.: 2014/30/EU

And inspected according to following

EU - Norms:

- EN 60 974-1:2012
- EN 60 974-10:2014+A1

Any alteration or change to these machines by any unauthorized person makes this Declaration invalid.

Wilkinson Star model

JPA-180
JA-200

Jasic Model

Arc 180 Z211
Arc 200 Z209

Authorised Representative

Wilkinson Star Limited
Shield Drive, Wardley Industrial Estate,
Worsley, Manchester M28 2WD
Tel 0161 793 8127

Manufacturer

Shenzhen Jasic Technology Co LTD
No3 Qinglan, 1st Road
Pingshan District
Shenzhen, China

Signature

Dr John A Wilkinson OBE

Position Chairman

Signature

Shenzhen Jasic Technology Co LTD

Position

Date



Date



STATEMENT OF WARRANTY

All new JASIC welders, plasma cutters and multi-process units sold through our partner Wilkinson Star Limited within the United Kingdom & Ireland shall be warranted to the original owner, non transferable, against failure due to defective materials or production. The warranty period is 5 years following the date of purchase. We recommend you register your product within 28 days of purchase. The original invoice is documentation for the standard warranty period. The warranty period is based on a single shift pattern.

Defective units shall be repaired or replaced by the company at our workshop. The company may opt to refund the purchase price (less any costs and depreciation due to use and wear). The company reserves the right to alter the warranty conditions at any time with effect for the future.

A prerequisite for the full warranty is that products are operated in accordance with the operating instructions supplied, observing the relevant installation and any legal requirements recommendations and guidelines and carrying out the maintenance instructions shown in the operator manual. This should be carried out by a suitably qualified competent person.

In the unlikely event of a problem, this should be reported to Jasic technical support team to review the claim.

The customer has no claim to loan or replacement products whilst repairs are being performed.

The following falls outside the scope of the warranty:

- Defects due to natural wear and tear
- Failure to observe the operating and maintenance instructions
- Connection to an incorrect or faulty mains supply
- Overloading during use
- Any modifications that are made to the product without the prior written consent
- Software errors due incorrect operation
- Any repairs that are carried out using non-approved spare parts
- Any transport or storage damage
- Direct or indirect damage as well as any loss of earnings are not covered under the warranty
- External damage such as fire or damage due to natural causes e.g. flooding

NOTE: Under the terms of the warranty, welding torches, their consumable parts, wire feed unit drive rolls and guide tubes, work return cables and clamps, electrode holders, connection and extension cables, mains and control leads, plugs, wheels, coolant etc. are covered with a 3 month warranty.

Jasic shall in no event be responsible for any third party expenses or expenses/costs or any indirect or consequential expenses/costs.

Jasic will submit an invoice for any repair work performed outside the scope of the warranty. A quotation for any non warranty will be raised prior to any repairs being carried out.

The decision about repair or replacement of the defective part(s) is made by Jasic. The replaced part(s) remain(s) Jasic property.

Warranty extends only to the machine, its accessories and parts contained inside. No other warranty is expressed or implied. No warranty is expressed or implied in regards to the fitness of the product for any particular application or use.

For further information on Jasic product warranty terms and product warranty registration please visit:

www.jasic-warranty.co.uk/terms

www.jasic-warranty.co.uk

SCHEMATIC

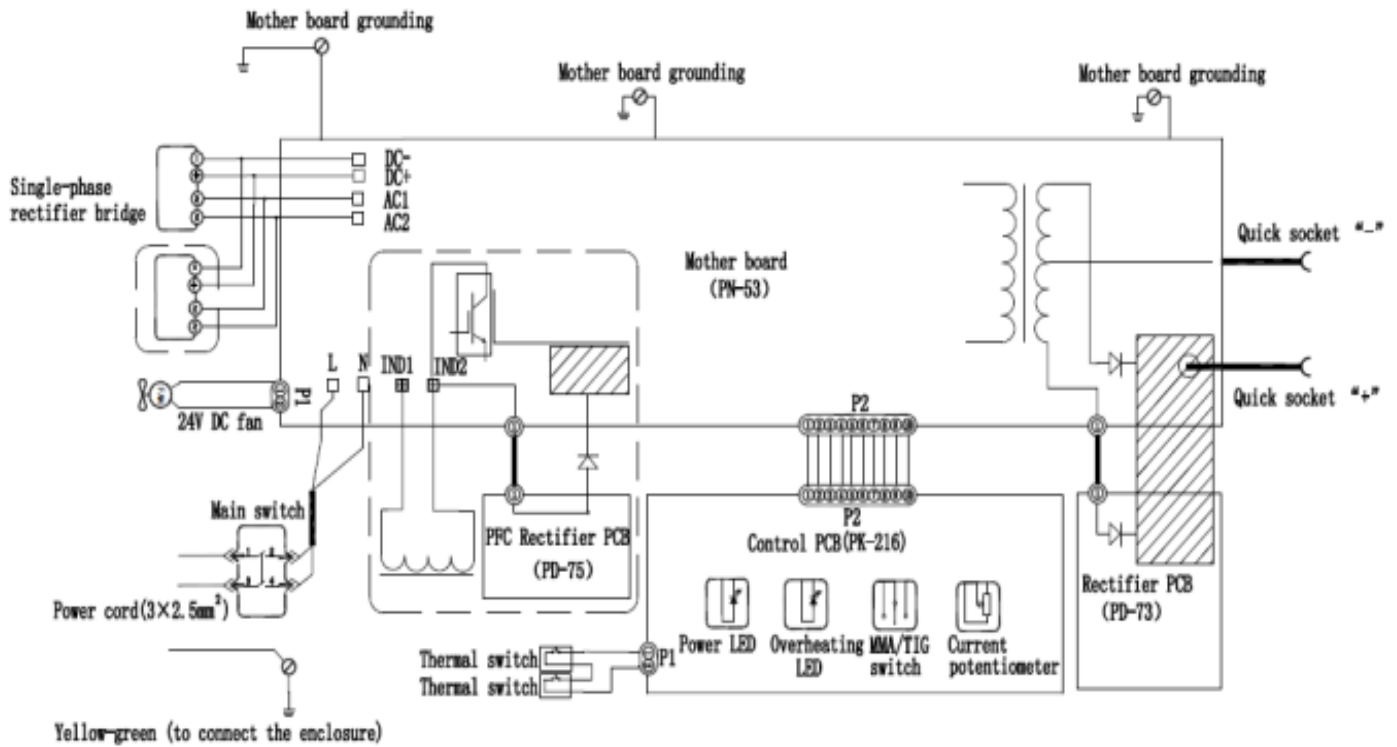

OPTIONS AND ACCESSORIES

Part Number	Description
WP17V-12-2DL	Valve TIG Torch, 12.5ft, 2 Piece c/w CP3550 Plug and extended 2mt Gas Hose
WCS25-3WEL	Welding Cable Set (MMA) 3m
WC-2-03LD	Electrode Holder and lead 3m
EC-2-03LD	Work Return Lead and Clamp 3m
CP3550	Cable Plug 35-50mm
JSS-01	Jasic Carry Strap
JSB-01	Jasic Site Bag
JH-HDX	Jasic HD True Colour Auto Darkening Welding Helmet
WP17V-12-2DL	17V TIG Torch, 12.5ft, 2 Pc Cable c/w CP3550 Plug and 2mt extended Gas Hose
WP26V-12-2DL	26V TIG Torch, 12.5ft, 2 Pc Cable c/w CP3550 plug and 2mt extended Gas Hose

Wilkinson Star Limited

Shield Drive

Wardley Industrial Estate

Worsley

Manchester

UK

M28 2WD

+44 (0)161 793 8127



JASIC

www.jasic.co.uk

November 2021 - Issue 6